

MBR20U150CT / MBR20U150FCT

List

List..... 1

Package outline..... 2

Features..... 2

Mechanical data..... 2

Maximum ratings 2

Electrical characteristics..... 2

Rating and characteristic curves..... 3

Pinning information..... 4

Marking..... 4

Tube packing..... 4

Suggested thermal profiles for soldering processes..... 5

High reliability test capabilities..... 6

Part Nomenclature

MBR20 U 150 XXX

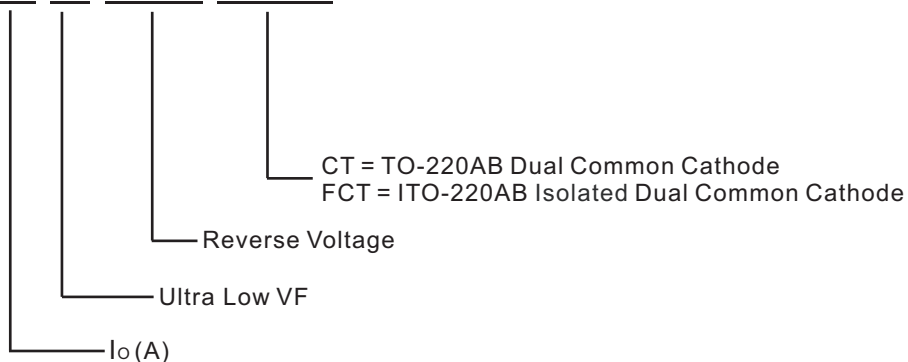

MBR20U150CT / MBR20U150FCT

20A High Barrier Ultra Low VF Power Schottky Rectifiers - 150V

Package outline

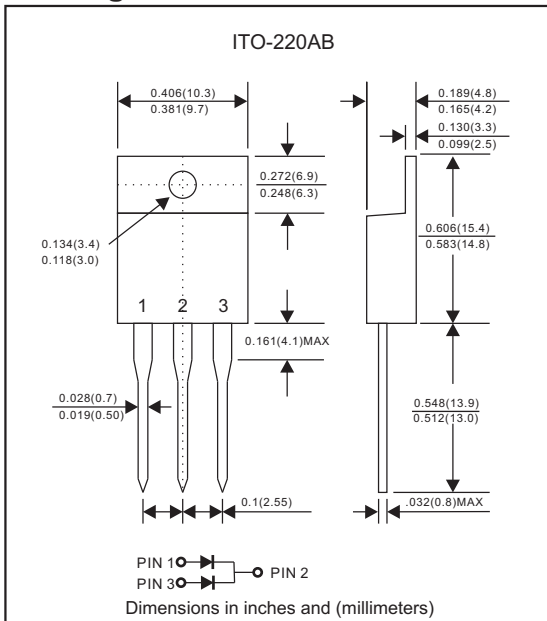

Package outline

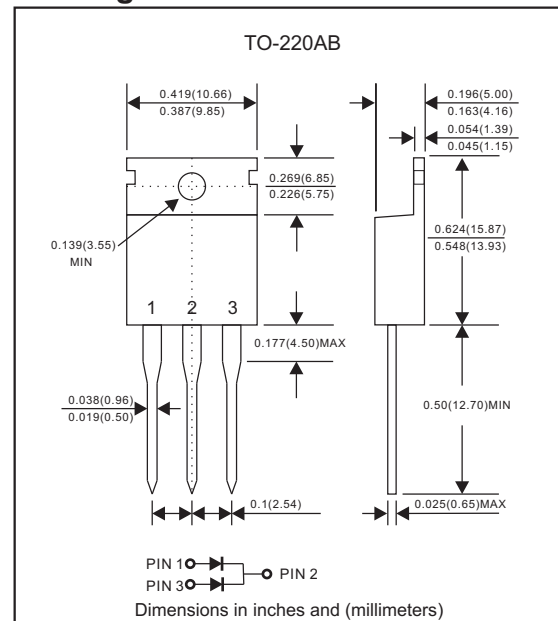

Features

- 175°C operating junction temperature.
- Offer 10A half wave and 20A full wave rectification.
- Low power loss, high efficiency.
- Ultra Low Forward Voltage Drop.
- High current capability
- High surge capability.
- Guardring for overvoltage protection.
- Low stored charge majority carrier conduction
- Lead-free parts meet RoHS requirements.
- Suffix "-H" indicates Halogen-free part, ex. MBR20U150CT-H.

Mechanical data

- Epoxy : UL94-V0 rated flame retardant
- Case : JEDEC ITO-220AB or TO-220AB molded plastic body over passivated chip
- Lead : Axial leads, solderable per MIL-STD-202, Method 208 guranteed
- Polarity: As marked
- Mounting Position : Any
- Weight : ITO-220AB Approximated 1.70 gram
- Weight : TO-220AB Approximated 2.10 gram

Maximum ratings (AT $T_A=25^\circ\text{C}$ unless otherwise noted)

PARAMETER	Symbol	MBR20U150CT	MBR20U150FCT	Unit
Maximum repetitive peak reverse voltage	V_{RRM}	150		Volts
Maximum RMS voltage	V_{RMS}	105		Volts
Maximum DC blocking voltage	V_{DC}	150		Volts
Maximum average forward rectified current See Fig. 1	I_O	20		A
Peak forward surge current 8.3ms single half sine-wave	I_{FSM}	150		A
Operating junction temperature range	T_J	-65 to +175		°C
Storage temperature range	T_{STG}	-65 to +175		°C

Electrical characteristics (AT $T_A=25^\circ\text{C}$ unless otherwise noted)

PARAMETER	Symbol	MBR20U150CT	MBR20U150FCT	Unit
Maximum forward voltage per leg at $I_F=10\text{A}$ $T_J=25^\circ\text{C}$	V_F	0.80		Volts
Typical forward voltage per leg at $I_F=20\text{A}$ $T_J=25^\circ\text{C}$		0.68		
		0.84		
		0.74		
Maximum reverse current at rated V_{DC} per leg $T_J=25^\circ\text{C}$	I_R	0.01		mA
		10		

Thermal characteristics

PARAMETER	Symbol	MBR20U150CT	MBR20U150FCT	Unit
Typical thermal resistance junction to case per leg	$R_{\theta JC}$	2.0	4.0	°C/W

Rating and characteristic curves (MBR20U150CT / MBR20U150FCT)

Fig. 1 - Forward Current Derating Curve

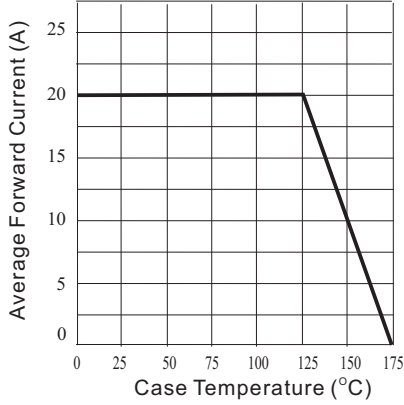

Fig. 2 - Maximum Non-Repetitive Peak Forward Surge Current

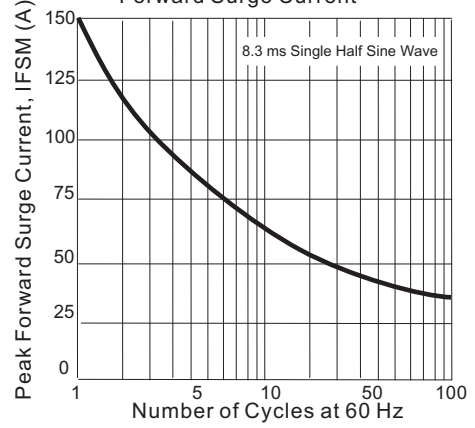

Fig. 3 - Typical Forward Characteristics

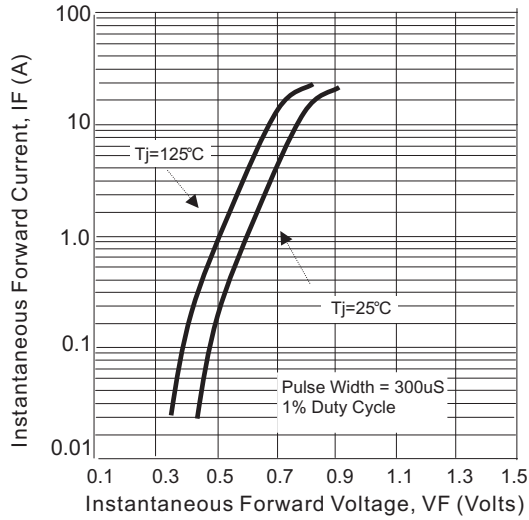
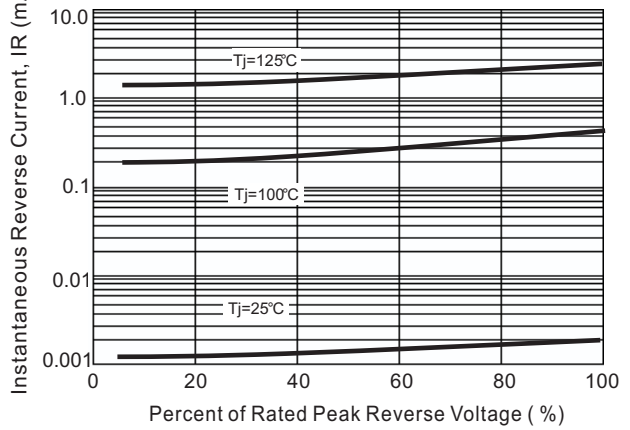

Fig. 4 - Typical Reverse Characteristics



MBR20U150CT / MBR20U150FCT

Pinning information

Pin	Simplified outline	Symbol
Pin1 anode Pin2 cathode Pin3 anode		

Marking

Type number	Marking code
MBR20U150CT	MBR20U150CT
MBR20U150FCT	MBR20U150FCT

Tube packing

PACKAGE	TUBE (pcs)	TUBE SIZE (m/m)	BOX (pcs)	INNER BOX (m/m)	CARTON SIZE (m/m)	CARTON (pcs)	APPROX. GROSS WEIGHT (kg)
ITO-220AB	50	525*32*7.0	1000	555*150*40	580*230*175	5,000	15.0

PACKAGE	TUBE (pcs)	TUBE SIZE (m/m)	BOX (pcs)	INNER BOX (m/m)	CARTON SIZE (m/m)	CARTON (pcs)	APPROX. GROSS WEIGHT (kg)
TO-220AB	50	525*32*7.5	1000	555*150*40	580*230*175	5,000	15.0

MBR20U150CT / MBR20U150FCT

Suggested thermal profiles for soldering processes

1. Lead free temperature profile wave-soldering

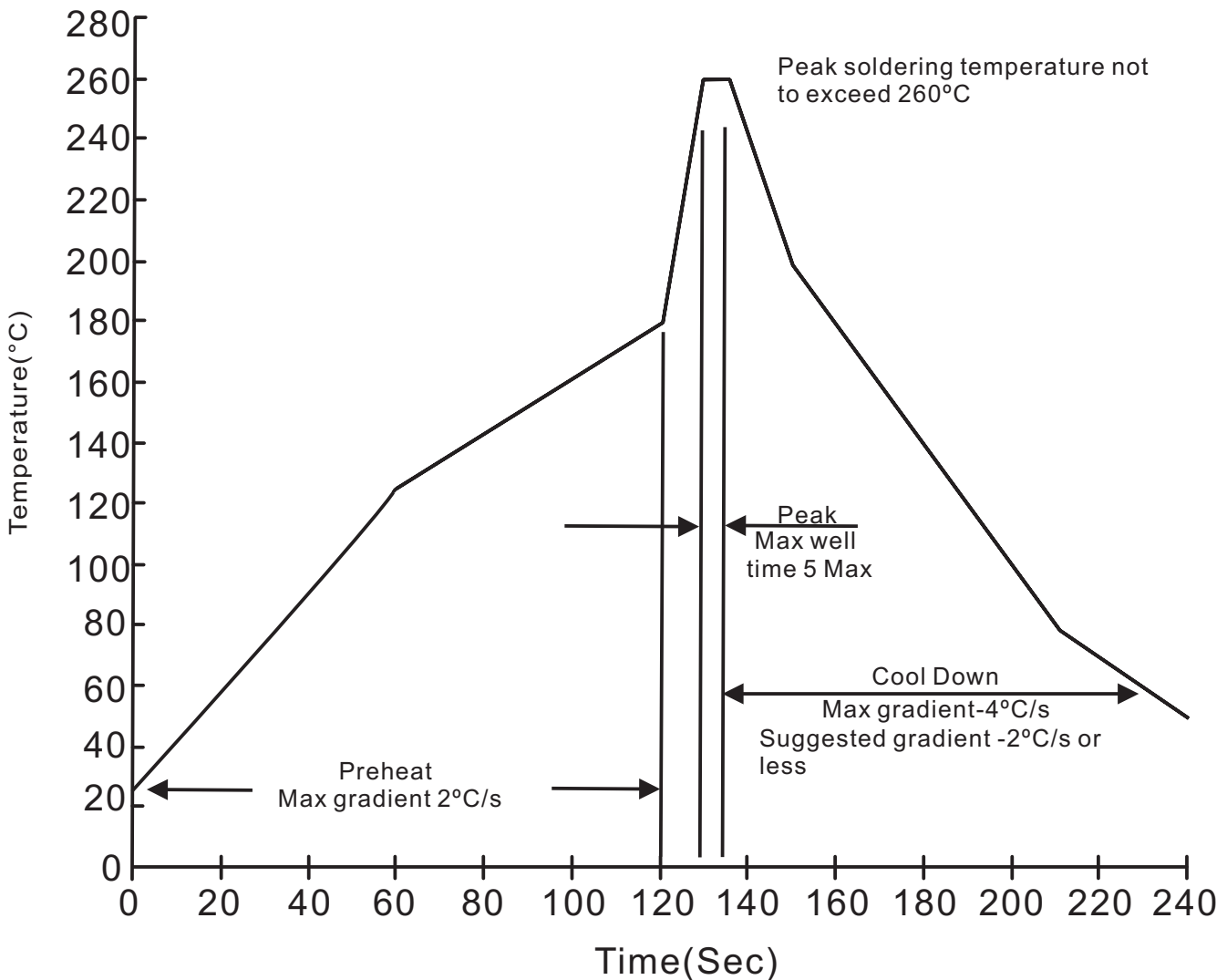

MBR20U150CT / MBR20U150FCT**High reliability test capabilities**

Item Test	Conditions	Reference
1. Solder Resistance	at $260\pm 5^{\circ}\text{C}$ for $10\pm 2\text{sec}$. immerse body into solder $1/16''\pm 1/32''$	MIL-STD-750D METHOD-2031
2. Solderability	at $245\pm 5^{\circ}\text{C}$ for 5 sec.	MIL-STD-202F METHOD-208
3. High Temperature Reverse Bias	$V_R=80\%$ rate at $T_J=175^{\circ}\text{C}$ for 168 hrs.	MIL-STD-750D METHOD-1038
4. Forward Operation Life	Rated average rectifier current at $T_A=25^{\circ}\text{C}$ for 500hrs.	MIL-STD-750D METHOD-1027
5. Intermittent Operation Life	$T_A = 25^{\circ}\text{C}$, $I_F = I_o$ On state: power on for 5 min. off state: power off for 5 min. on and off for 500 cycles.	MIL-STD-750D METHOD-1036
6. Pressure Cooker	$15P_{SIG}$ at $T_A=121^{\circ}\text{C}$ for 4 hrs.	JESD22-A102
7. Temperature Cycling	-55°C to $+125^{\circ}\text{C}$ dwelled for 30 min. and transferred for 5min. total 10 cycles.	MIL-STD-750D METHOD-1051
8. Forward Surge	8.3ms single half sine-wave , one surge.	MIL-STD-750D METHOD-4066-2
9. Humidity	at $T_A=85^{\circ}\text{C}$, RH=85% for 1000hrs.	MIL-STD-750D METHOD-1021
10. High Temperature Storage Life	at 175°C for 1000 hrs.	MIL-STD-750D METHOD-1031