

FM120-NS THRU FM140-NS

List

List..... 1

Package outline..... 2

Features..... 2

Mechanical data..... 2

Maximum ratings and Electrical characteristics2

Rating and characteristic curves..... 3

Pinning information.....4

Marking..... 4

Suggested solder pad layout..... 4

Packing information..... 5

Reel packing..... 6

Suggested thermal profiles for soldering processes..... 6

High reliability test capabilities.....7

FM120-NS THRU FM140-NS

1.0A Surface Mount Schottky Barrier Rectifiers - 20V-40V

Features

- Batch process design, excellent power dissipation offers better reverse leakage current and thermal resistance
- Low profile surface mounted application in order to optimize board space
- Low power loss, high efficiency
- High current capability, low forward voltage drop
- High surge capability
- Guardring for overvoltage protection
- Very tiny plastic SMD package
- Ultra high-speed switching
- Silicon epitaxial planar chip, metal silicon junction
- Lead-free parts meet RoHS requirements
- Suffix "-H" indicates Halogen free parts, ex. FM120-NS-H

Mechanical data

- Epoxy:UL94-V0 rated flame retardant
- Case : Molded plastic, SOD-323S
- Terminals : Solder plated, solderable per MIL-STD-750, Method 2026
- Polarity : Indicated by cathode band
- Mounting Position : Any
- Weight : Approximated 0.004 gram

Package outline

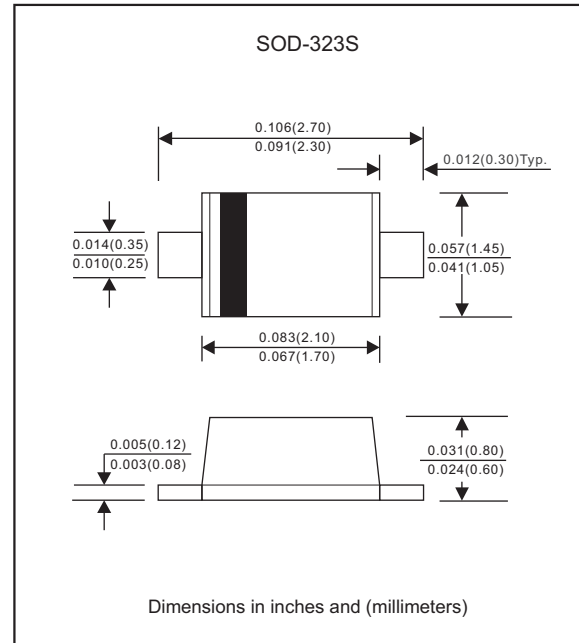

Maximum ratings (AT $T_A=25^\circ\text{C}$ unless otherwise noted)

PARAMETER	SYMBOLS	FM120-NS	FM130-NS	FM140-NS	UNITS
Maximum repetitive peak reverse voltage	V_{RRM}	20	30	40	Volts
Maximum RMS voltage	V_{RMS}	14	21	28	Volts
Maximum continuous reverse voltage	V_R	20	30	40	Volts
Maximum average forward rectified current	I_O	1.0			Amps
Non-repetitive peak forward surge current 8.3ms single half sine-wave (JEDEC methode)	I_{FSM}	25			Amps
Typical diode junction capacitance (Note 1)	C_J	38			pF
Operating junction temperature range	T_J	-55 to +125			$^\circ\text{C}$
Storage temperature range	T_{STG}	-65 to +175			$^\circ\text{C}$

Electrical characteristics (AT $T_A=25^\circ\text{C}$ unless otherwise noted)

PARAMETER	SYMBOLS	FM120-NS	FM130-NS	FM140-NS	UNITS
Maximum instantaneous forward voltage at $I_F=1.0\text{A}$	V_F	0.55			Volts
Maximum reverse leakage current at rated V_R	I_R		0.5 10		mA mA
			$T_J=25^\circ\text{C}$		
			$T_J=100^\circ\text{C}$		

Thermal characteristics

PARAMETER	SYMBOLS	FM120-NS	FM130-NS	FM140-NS	UNITS
Typical thermal resistance junction to ambient (Note 2)	$R_{\theta JA}$	120			$^\circ\text{C} / \text{W}$
Typical thermal resistance junction to case (Note 2)	$R_{\theta JC}$	100			$^\circ\text{C} / \text{W}$

Notes 1: Measured at 1 MHz and applied reverse voltage of 4.0 VDC
 2: Mounted on FR-4 PCB copper, minimum recommended pad layout

Rating and characteristic curves (FM120-NS THRU FM140-NS)

FIG.1-TYPICAL FORWARD CURRENT DERATING CURVE

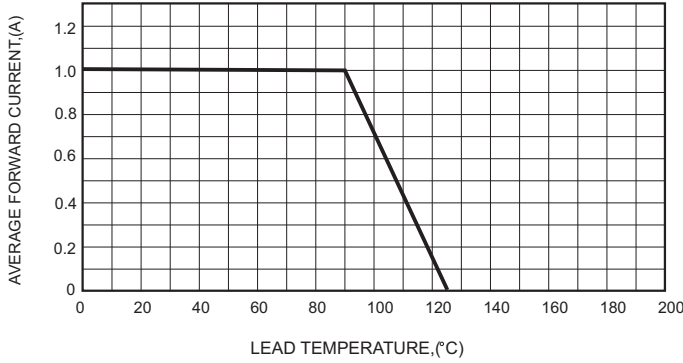

FIG.2-TYPICAL FORWARD CHARACTERISTICS

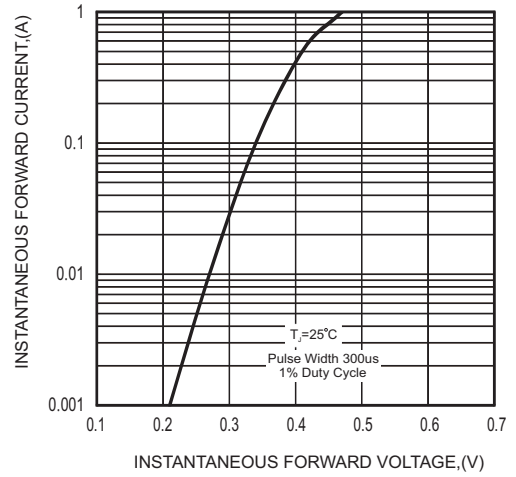

FIG.3-MAXIMUM NON-REPETITIVE FORWARD SURGE CURRENT

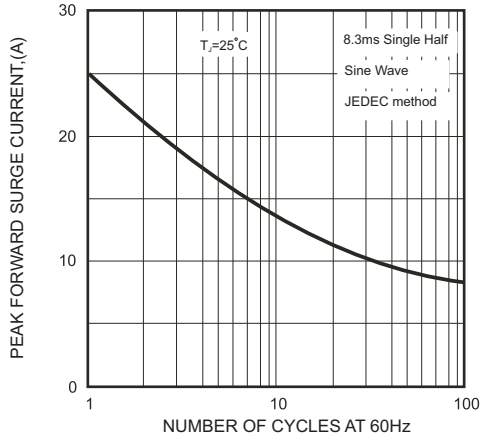

FIG.4-TYPICAL JUNCTION CAPACITANCE

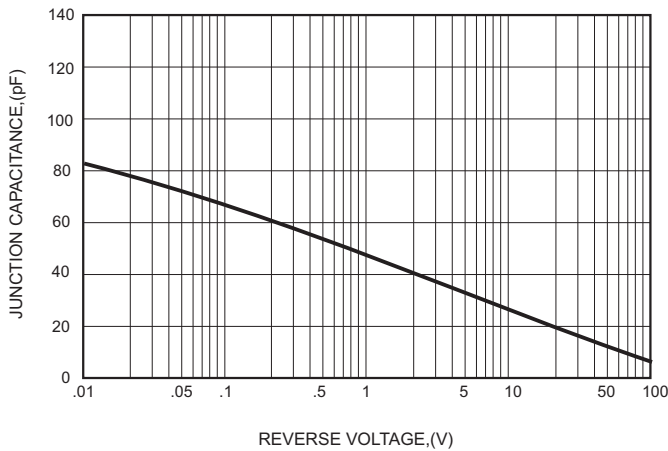
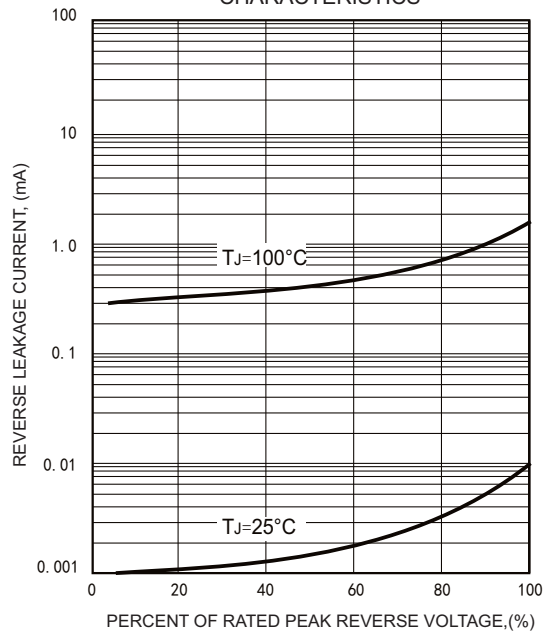



FIG.5 - TYPICAL REVERSE CHARACTERISTICS



FM120-NS THRU FM140-NS

Pinning information

Pin	Simplified outline	Symbol
Pin1 cathode Pin2 anode		

Marking

Type number	Marking code
FM120-NS	12
FM130-NS	13
FM140-NS	14

Suggested solder pad layout

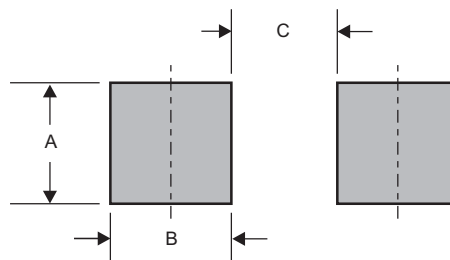

Dimensions in inches and (millimeters)

PACKAGE	A	B	C
SOD-323S	0.024 (0.60)	0.031 (0.80)	0.059 (1.50)

FM120-NS THRU FM140-NS

Packing information

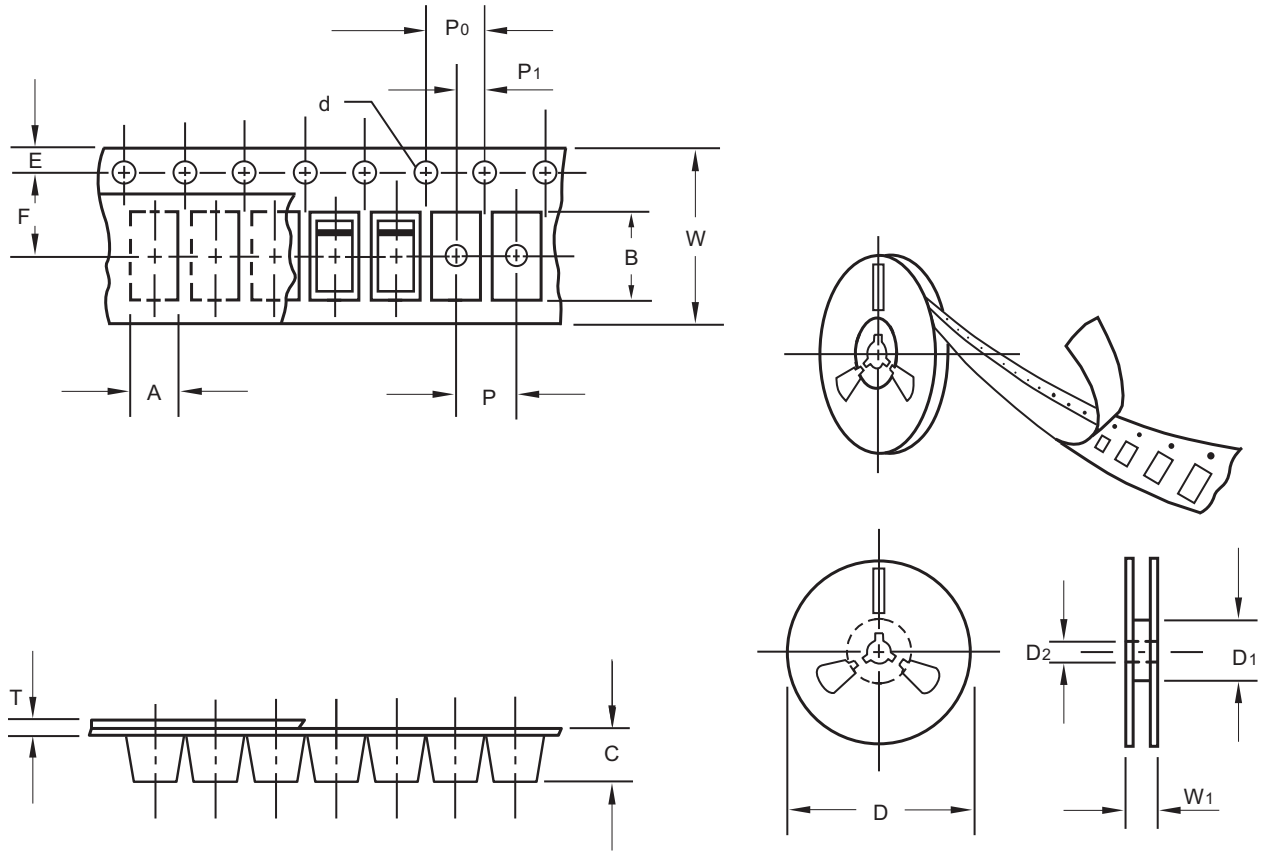

unit:mm

Item	Symbol	Tolerance	SOD-323S
Carrier width	A	0.1	1.40
Carrier length	B	0.1	2.95
Carrier depth	C	0.1	0.95
Sprocket hole	d	0.1	1.50
13" Reel outside diameter	D	2.0	-
13" Reel inner diameter	D1	min	-
7" Reel outside diameter	D	2.0	178.00
7" Reel inner diameter	D1	min	62.00
Feed hole diameter	D2	0.5	13.00
Sprocket hole position	E	0.1	1.75
Punch hole position	F	0.1	3.50
Punch hole pitch	P	0.1	4.00
Sprocket hole pitch	P0	0.1	4.00
Embossment center	P1	0.1	2.00
Overall tape thickness	T	0.1	0.23
Tape width	W	0.3	8.00
Reel width	W1	1.0	11.40

Note: Devices are packed in accordance with EIA standard RS-481-A and specifications listed above.

FM120-NS THRU FM140-NS

Reel packing

PACKAGE	REEL SIZE	REEL (pcs)	COMPONENT SPACING (m/m)	BOX (pcs)	INNER BOX (m/m)	REEL DIA, (m/m)	CARTON SIZE (m/m)	CARTON (pcs)	APPROX. GROSS WEIGHT (kg)
SOD-323S	7"	3,000	4.0	30,000	183*123*183	178	382*257*387	240,000	9.5

Suggested thermal profiles for soldering processes

- 1.Storage environment: Temperature=5°C~40°C Humidity=55%±25%
- 2.Reflow soldering of surface-mount devices

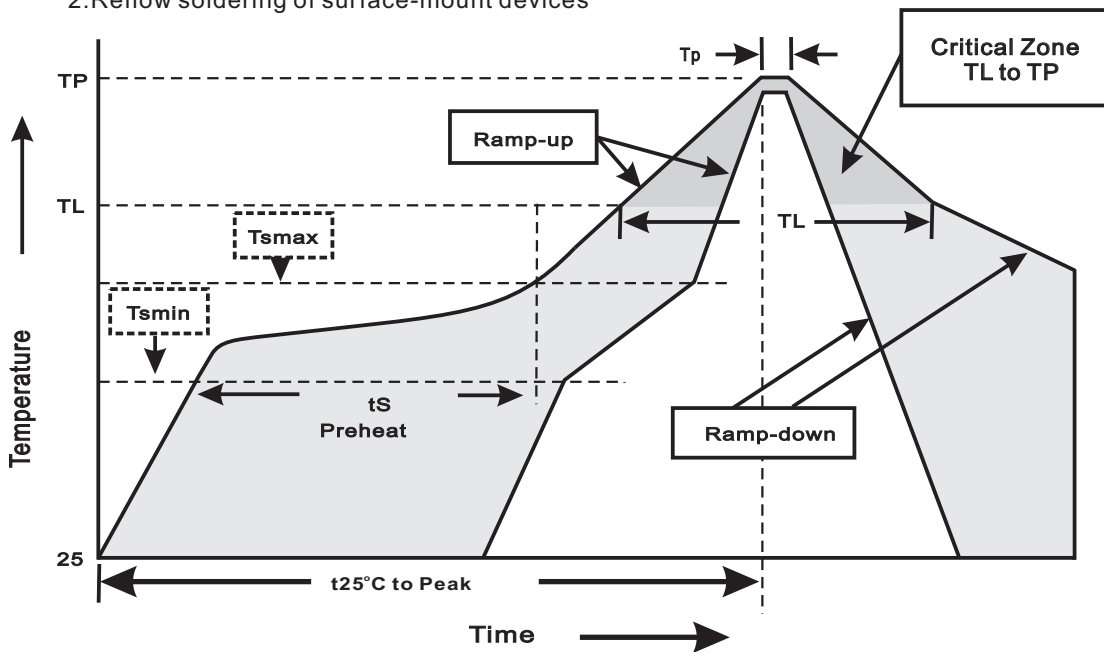

3.Reflow soldering

Profile Feature	Soldering Condition
Average ramp-up rate(T _L to T _P)	<3°C/sec
Preheat -Temperature Min(T _{min}) -Temperature Max(T _{max}) -Time(min to max)(t _s)	150°C 200°C 60~120sec
T _{max} to T _L -Ramp-upRate	<3°C/sec
Time maintained above: -Temperature(T _L) -Time(t _L)	217°C 60~260sec
Peak Temperature(T _P)	255°C-0/+5°C
Time within 5°C of actual Peak Temperature(t _P)	10~30sec
Ramp-down Rate	<6°C/sec
Time 25°C to Peak Temperature	<6minutes

FM120-NS THRU FM140-NS**High reliability test capabilities**

Item Test	Conditions	Reference
1. Solder Resistance	at 260±5°C for 10±2sec.	MIL-STD-750D METHOD-2031
2. Solderability	at 245±5°C for 5 sec.	MIL-STD-202F METHOD-208
3. High Temperature Reverse Bias	$V_R=80\%$ rate at $T_J=125^\circ\text{C}$ for 168 hrs.	MIL-STD-750D METHOD-1038
4. Forward Operation Life	Rated average rectifier current at $T_A=25^\circ\text{C}$ for 500hrs.	MIL-STD-750D METHOD-1027
5. Intermittent Operation Life	$T_A = 25^\circ\text{C}$, $I_F = I_O$ On state: power on for 5 min. off state: power off for 5 min. on and off for 500 cycles.	MIL-STD-750D METHOD-1036
6. Pressure Cooker	15P _{SIG} at $T_A=121^\circ\text{C}$ for 4 hrs.	JESD22-A102
7. Temperature Cycling	-55°C to +125°C dwelled for 30 min. and transferred for 5min. total 10 cycles.	MIL-STD-750D METHOD-1051
8. Forward Surge	8.3ms single half sine-wave , one surge.	MIL-STD-750D METHOD-4066-2
9. Humidity	at $T_A=85^\circ\text{C}$, RH=85% for 1000hrs.	MIL-STD-750D METHOD-1021
10. High Temperature Storage Life	at 175°C for 1000 hrs.	MIL-STD-750D METHOD-1031