

FM201-MST THRU FM207-MST

List

List..... 1

Package outline..... 2

Features..... 2

Mechanical data..... 2

Maximum ratings and Electrical characteristics 2

Rating and characteristic curves..... 3

Pinning information..... 4

Marking..... 4

Suggested solder pad layout..... 4

Packing information..... 5

Reel packing..... 6

Suggested thermal profiles for soldering processes..... 6

High reliability test capabilities..... 7

FM201-MST THRU FM207-MST

2.0A Surface Mount General Purpose Rectifiers 50V-1000V

Features

- Well package design with solder pad on the bottom for best thermal performance
- Low profile package 0.95 mm (typ.)
- Tiny plastic SMD package
- Glass passivated chip junction
- Ideal for automated placement
- High current capability
- High surge capability
- Lead free parts meet RoHS requirements
- Suffix "-H" indicates Halogen-free parts, ex. FM201-MST-H

Mechanical data

- Epoxy : UL94-V0 rated flame retardant
- Case : Molded plastic, SOD-123ST / MINI SMA
- Terminals :Plated terminals, solderable per MIL-STD-750, Method 2026
- Polarity : Indicated by cathode band
- Mounting Position : Any
- Weight : Approximated 0.0155 gram

Package outline

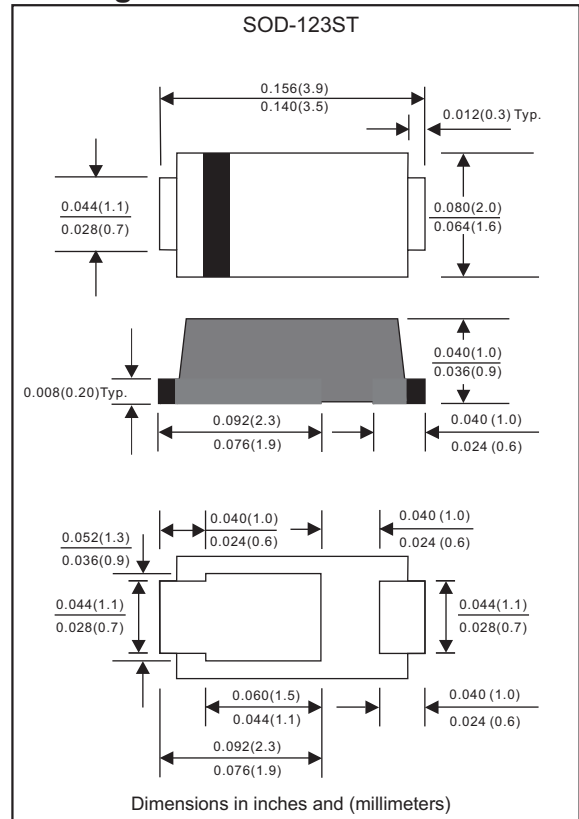

Maximum ratings (AT $T_A=25^{\circ}\text{C}$ unless otherwise noted)

PARAMETER	SYMBOLS	FM201-MST	FM202-MST	FM203-MST	FM204-MST	FM205-MST	FM206-MST	FM207-MST	UNIT
Maximum repetitive peak reverse voltage	V_{RRM}	50	100	200	400	600	800	1000	V
Maximum RMS voltage	V_{RMS}	35	70	140	280	420	560	700	V
Maximum continuous reverse voltage	V_R	50	100	200	400	600	800	1000	V
Maximum average forward rectified current	I_o	2.0							A
Non-repetitive peak forward surge current 8.3ms single half sine-wave (JEDEC methode)	I_{FSM}	35							A
Typical junction capacitance, Note 1	C_J	12							pF
Operating junction temperature range	T_J	-55 to +150							$^{\circ}\text{C}$
Storage temperature range	T_{STG}	-65 to +175							$^{\circ}\text{C}$

Electrical characteristics (AT $T_A=25^{\circ}\text{C}$ unless otherwise noted)

PARAMETER	SYMBOLS	FM201-MST	FM202-MST	FM203-MST	FM204-MST	FM205-MST	FM206-MST	FM207-MST	UNIT
Maximum instantaneous forward voltage at $I_F=2.0A$	V_F	1.1							V
Maximum reverse leakage current at rated V_R	I_R	5.0 100							μA μA

Thermal characteristics

PARAMETER	SYMBOLS	FM201-MST	FM202-MST	FM203-MST	FM204-MST	FM205-MST	FM206-MST	FM207-MST	UNIT
Typical thermal resistance junction to ambient, Note 2	$R_{\theta JA}$	50							$^{\circ}\text{C}/\text{W}$
Typical thermal resistance junction to case, Note 2	$R_{\theta JC}$	30							$^{\circ}\text{C}/\text{W}$

Notes1: Measured at 1MHz and applied reverse voltage of 4.0V D.C
 2: Mounted on FR-4 PCB copper, minimum recommended pad layout

Rating and characteristic curves (FM201-MST THRU FM207-MST)

FIG.1-TYPICAL FORWARD CHARACTERISTICS

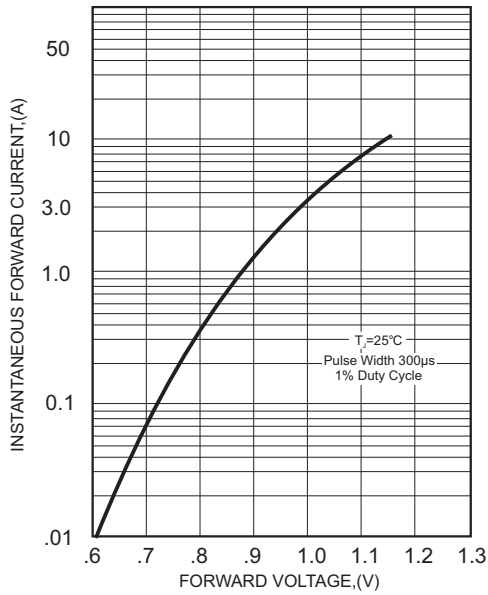

FIG.2-TYPICAL FORWARD CURRENT DERATING CURVE

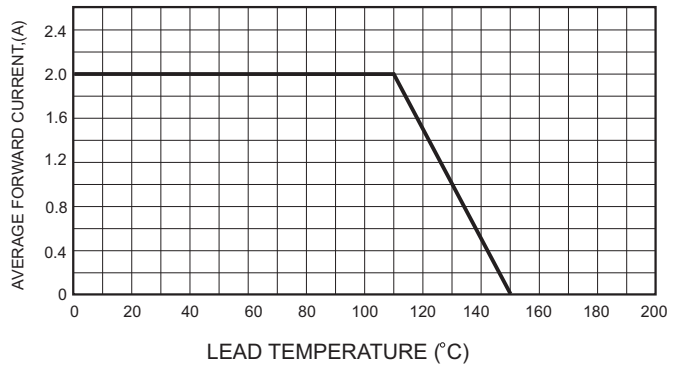

FIG.4-MAXIMUM NON-REPETITIVE FORWARD SURGE CURRENT

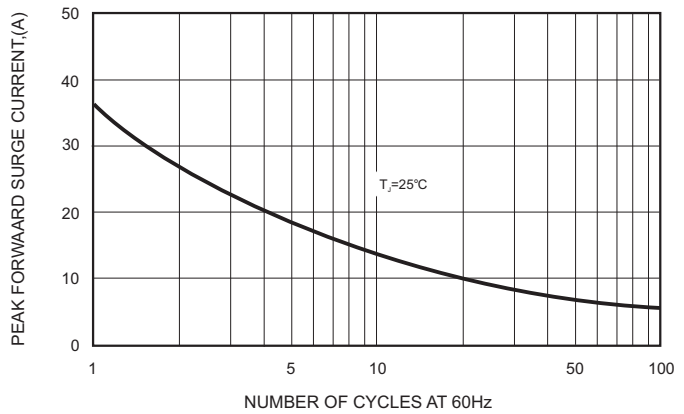

FIG.3 - TYPICAL REVERSE CHARACTERISTICS

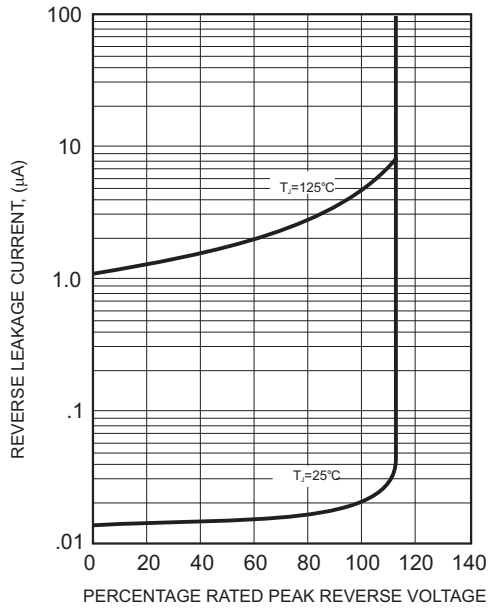
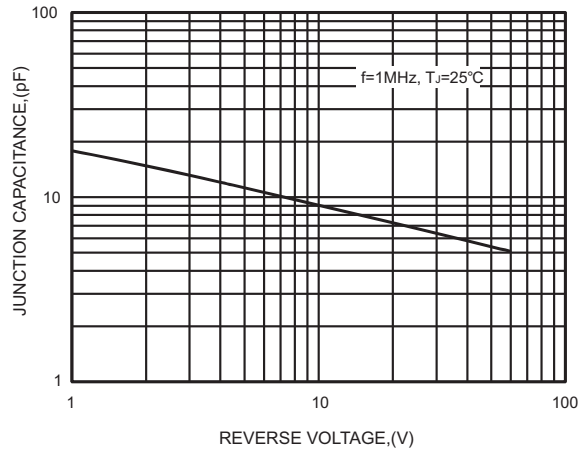



FIG.5-TYPICAL JUNCTION CAPACITANCE



FM201-MST THRU FM207-MST

Pinning information

Pin	Simplified outline	Symbol
Pin1 cathode Pin2 anode		

Marking

Type number	Marking code
FM201-MST	A21
FM202-MST	A22
FM203-MST	A23
FM204-MST	A24
FM205-MST	A25
FM206-MST	A26
FM207-MST	A27

Suggested solder pad layout

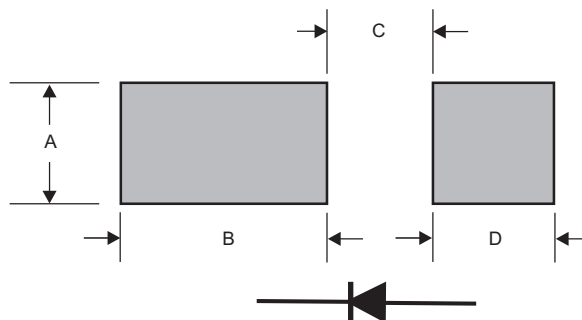

Dimensions in inches and (millimeters)

PACKAGE	A	B	C	D
SOD-123ST	0.036 (0.90)	0.084 (2.10)	0.032 (0.80)	0.032 (0.80)

FM201-MST THRU FM207-MST

Packing information

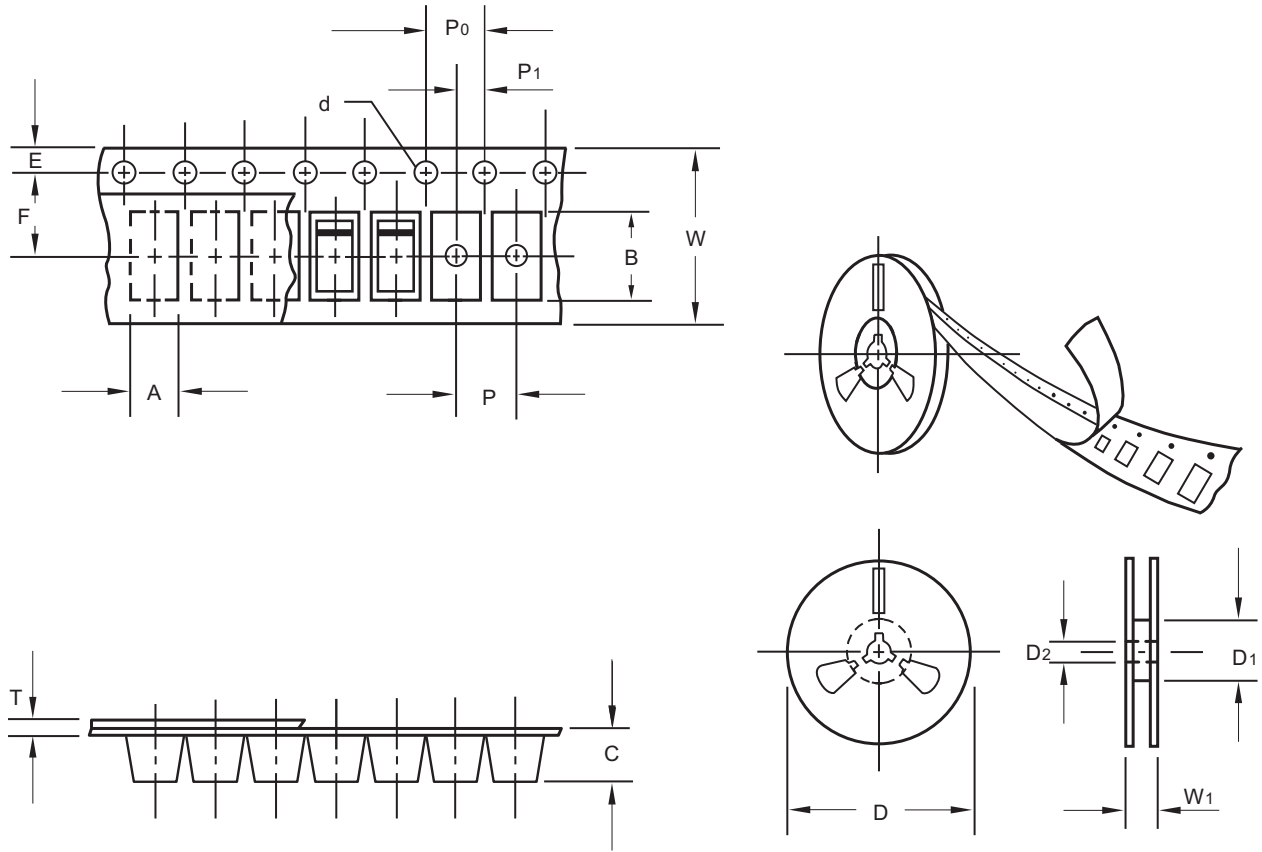

unit:mm

Item	Symbol	Tolerance	SOD-123ST
Carrier width	A	0.1	2.00
Carrier length	B	0.1	3.85
Carrier depth	C	0.1	1.10
Sprocket hole	d	0.1	1.50
13" Reel outside diameter	D	2.0	-
13" Reel inner diameter	D ₁	min	-
7" Reel outside diameter	D	2.0	178.00
7" Reel inner diameter	D ₁	min	62.00
Feed hole diameter	D ₂	0.5	13.00
Sprocket hole position	E	0.1	1.75
Punch hole position	F	0.1	3.50
Punch hole pitch	P	0.1	4.00
Sprocket hole pitch	P ₀	0.1	4.00
Embossment center	P ₁	0.1	2.00
Overall tape thickness	T	0.1	0.23
Tape width	W	0.3	8.00
Reel width	W ₁	1.0	11.40

Note: Devices are packed in accordance with EIA standard RS-481-A and specifications listed above.

FM201-MST THRU FM207-MST

Reel packing

PACKAGE	REEL SIZE	REEL (pcs)	COMPONENT SPACING (m/m)	BOX (pcs)	INNER BOX (m/m)	REEL DIA, (m/m)	CARTON SIZE (m/m)	CARTON (pcs)	APPROX. GROSS WEIGHT (kg)
SOD-123ST	7"	3,000	4.0	30,000	183*123*183	178	382*257*387	240,000	9.5

Suggested thermal profiles for soldering processes

- 1.Storage environment: Temperature=5°C~40°C Humidity=55%±25%
- 2.Reflow soldering of surface-mount devices

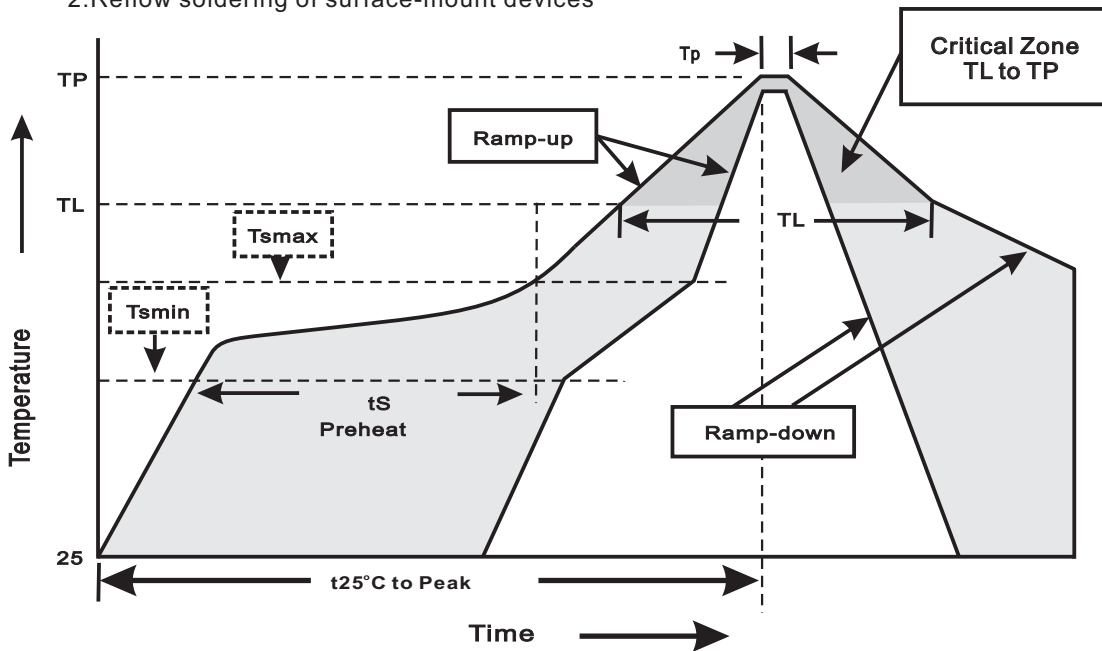

3.Reflow soldering

Profile Feature	Soldering Condition
Average ramp-up rate(TL to TP)	<3°C/sec
Preheat -Temperature Min(Tsmin) -Temperature Max(Tsmax) -Time(min to max)(ts)	150°C 200°C 60~120sec
Tsmax to TL -Ramp-upRate	<3°C/sec
Time maintained above: -Temperature(TL) -Time(tL)	217°C 60~260sec
Peak Temperature(TP)	255°C-0/+5°C
Time within 5°C of actual Peak Temperature(tP)	10~30sec
Ramp-down Rate	<3°C/sec
Time 25°C to Peak Temperature	<6minutes

FM201-MST THRU FM207-MST**High reliability test capabilities**

Item Test	Conditions	Reference
1. Solder Resistance	at 260±5°C for 10±2sec.	MIL-STD-750D METHOD-2031
2. Solderability	at 245±5°C for 5 sec.	MIL-STD-202F METHOD-208
3. High Temperature Reverse Bias	$V_R=80\%$ rate at $T_J=150^\circ\text{C}$ for 168 hrs.	MIL-STD-750D METHOD-1038
4. Forward Operation Life	Rated average rectifier current at $T_A=25^\circ\text{C}$ for 500hrs.	MIL-STD-750D METHOD-1027
5. Intermittent Operation Life	$T_A = 25^\circ\text{C}$, $I_F = I_O$ On state: power on for 5 min. off state: power off for 5 min. on and off for 500 cycles.	MIL-STD-750D METHOD-1036
6. Pressure Cooker	15P _{SIG} at $T_A=121^\circ\text{C}$ for 4 hrs.	JESD22-A102
7. Temperature Cycling	-55°C to +125°C dwelled for 30 min. and transferred for 5min. total 10 cycles.	MIL-STD-750D METHOD-1051
8. Forward Surge	8.3ms single half sine-wave , one surge.	MIL-STD-750D METHOD-4066-2
9. Humidity	at $T_A=85^\circ\text{C}$, RH=85% for 1000hrs.	MIL-STD-750D METHOD-1021
10. High Temperature Storage Life	at 175°C for 1000 hrs.	MIL-STD-750D METHOD-1031